





# **Piastre e Rulli Guida**





-  Rollers guide
-  Führungsrollen
-  Plots de guidage
-  Placas y Rodillos





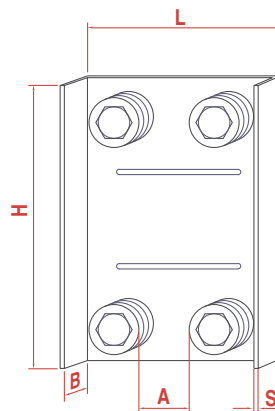

## Piastra con rulli guida piccola

-  Plate with rollers - small guide
-  Führungseinheiten kleine Schienen
-  Plaque de guidage petit modèle
-  Placas con 2° 4 rodillos guía pequeña





ARTICOLO - ARTICLE		L x H x S	A min/max	B	RULLI				
Riferimento-Reference		mm			N°	Riferimento-Reference	N°	kg	x1
2 RP	PZ 14 10 02	145 X 100 X 3	30/60	38	2	Art. BN 36	8	6.5	7,20
4 RP	PZ 14 20 04	145 X 200 X 3	30/60	38	4	Art. BN 36	4	6.1	12,10



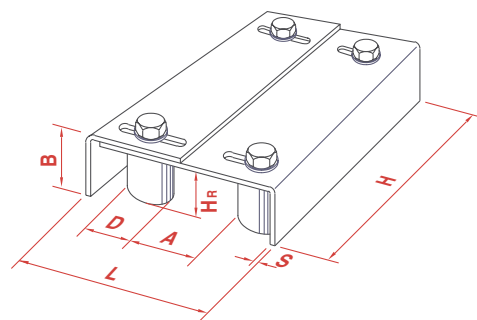

## Piastra con rulli guida media e grande

-  Plate with rollers - medium and large guide
-  Führungseinheiten mittel und groß
-  Plaque de guidage réglable - moyenne et grande
-  Placas regulables en altura con 4 rodillos guía mediana y grande





ARTICOLO - ARTICLE		L	H	S	A min/max	B	RULLI					
Riferimento-Reference		mm					∅ mm	N°	kg	x1		
4 RM	PZ 13 17 04	130 X 170	200	3	35/60	55	30	40	4	8.7	18,10	
4 RG	PZ 19 24 04	195 X 245	350	4	60/100	67	40	40	4	21	34,10	
Inox	4 RMI	PI 13 17 04	130 X 170	200	3	35/60	55	30	40	4	8.7	46,60

## Piastra rulli guida da tassellare a muro

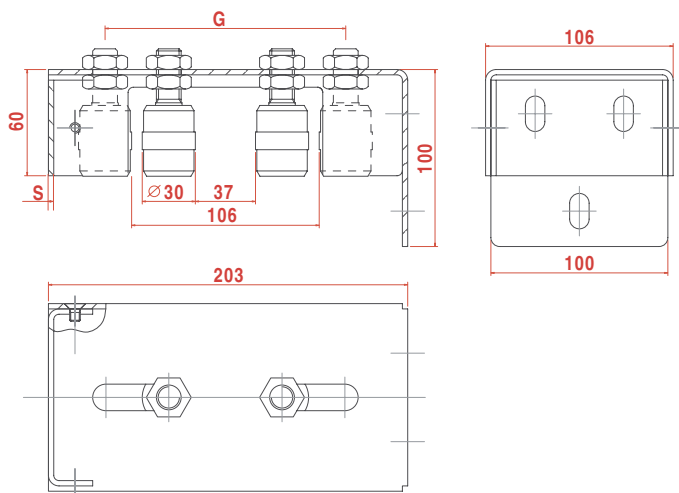



-  Guide plate to be fixed to wall
-  Führungsplatte am Wand zu befestigen
-  Plaque guide à fixer au mur
-  Placa regulable en altura con 2 rodillos para atornillar







ARTICOLO - ARTICLE		L x H x B	H1	S	G min/max	RULLI				
Riferimento-Reference		mm				N°	ART.	N°	kg	x1
2RG	PT 20 10 20	200x100x60	100	3	106/34	2	CN30	2	2.8	19,20

# Piastre e Rulli Guida

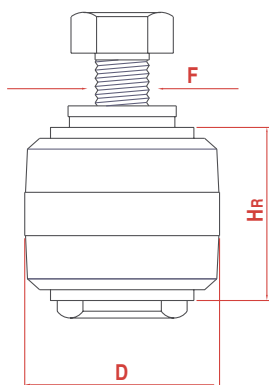



## Rullo guida in nylon bombato

-  Convex nylon roller
-  Ballige Führungsrollen aus Polyamid
-  Plot de guidage bombé
-  Rodillo de nylon abombado





ARTICOLO - ARTICLE		D	Hr	F			€
Riferimento-Reference		∅	mm	UNI	N°		x1
BN 36	UP 36 32 B0	36	32	M 10x20	50	6.4	2,40



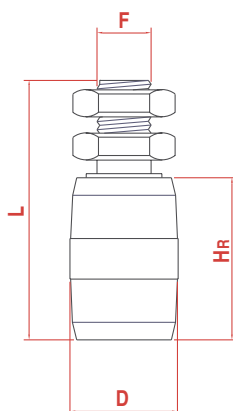

## Rullo guida in nylon cilindrico

-  Cylindrical nylon roller
-  Zylindrische Führungsrollen aus Polyamid
-  Plot de guidage en nylon cylindrique
-  Rodillos de nylon cilíndricos





ARTICOLO - ARTICLE		D	Hr	L	F			€
Riferimento-Reference		∅	mm	UNI	N°		x1	
CN 25	UP 25 40 C0	25	40	73	M 14	50	6.7	2,60
CN 28	UP 28 40 C0	28	40	73	M 14	50	7	2,90
CN 30	UP 30 40 C0	30	40	73	M 14	50	7.2	3,10
CN 32	UP 32 40 C0	32	40	73	M 14	50	7.4	3,30
CN 40	UP 40 60 C0	40	60	96	M 20	20	7.7	5,00
CN 42	UP 42 60 C0	42	60	96	M 20	20	7.9	5,30
CN 40/14	UP 40 60 C1	40	40	96	M14	40	14	4,00



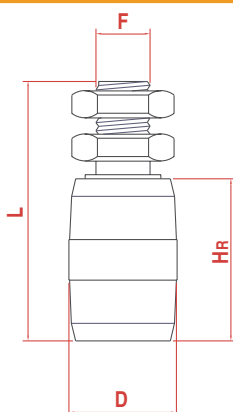

## Rullo guida in nylon cilindrico con perno inox

-  Cylindrical nylon roller stainless steel pin
-  Zylindrische Führungsrollen aus Polyamid, rostfrei
-  Plot de guidage inox en nylon cylindrique
-  Rodillos de nylon cilíndricos con tornillo de acero inoxidable







ARTICOLO - ARTICLE		D	Hr	L	F			€	
Riferimento-Reference		∅	mm	UNI	N°		x1		
Inox	CN 25 I	UI 25 40 C0	25	40	73	M 14	50	6.5	7,50
	CN 28 I	UI 28 40 C0	28	40	73	M 14	50	6.8	7,50
	CN 30 I	UI 30 40 C0	30	40	73	M 14	50	7	7,50
	CN 32 I	UI 32 40 C0	32	40	73	M 14	50	7.2	7,50
	CN 40 I	UI 40 60 C0	40	60	96	M 20	20	8	12,40
	CN 42 I	UI 42 60 C0	42	60	96	M 20	20	8.2	12,40

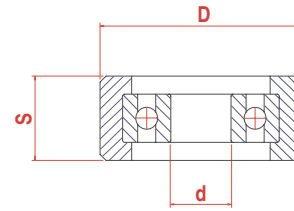



## Ruota in nylon Ø33 piana a 1 cuscinetto

-  Plain nylon wheel Ø 33 - 1 bearing
-  Nylon Rolle Ø 33 - 1 - Lager
-  Roue nylon Ø 33 - 1 roulement
-  Rueda nylon 1 cojinete Ø33







ARTICOLO - ARTICLE		D	d	S			
Riferimento-Reference		∅	∅	mm	N°		x1
RN 33	RP 33 14 CX	33	10	14	150	3.6	2,40

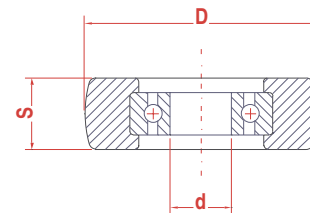



## Ruote in nylon piane con cuscinetto

-  Plain nylon wheels with bearing
-  Nylonrolle mit Lager
-  Roue en nylon avec roulement
-  Ruedas nylon planas con cojinete





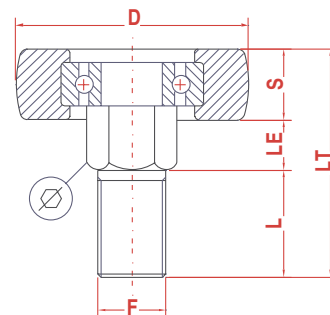

ARTICOLO - ARTICLE		D	d	S			
Riferimento-Reference		∅	∅	mm	N°		x1
RN 40	RP 40 15 CX	40	12	15	150	4.7	3,50
RN 48	RP 48 15 CX	48	12	15	100	4	4,40
RN 60	RP 60 19 CX	60	17	19	50	4.7	6,30
RN 65	RP 65 19 CX	65	17	19	50	5.3	6,90
RN 65 F 20	RP 65 19 1X	65	20	19	50	5.9	6,90
RN 70	RP 70 19 CX	70	17	19	50	5.8	7,60
RN 80	RP 80 23 CX	80	20	23	50	5.6	8,90
RN 80 F25	RP 80 23 1X	80	25	23	30	6.5	8,90

## Ruote in nylon piane con cuscinetto con perno filettato

-  Plain nylon wheels with bearing & threaded pin
-  Nylonrolle mit Gewinbolzen mit Lager
-  Roue en nylon avec roulement et axe fileté
-  Ruedas nylon planas con cojinete con tornillo fileteado



ARTICOLO - ARTICLE		D	S	FxL						
Riferimento-Reference		∅	mm			N°		x1		
RNF 40	RP 40 15 F0	40	15	M 14x40	17	8	63	50	6.6	5,90
RNF 48	RP 48 15 F0	48	15	M 14x40	17	8	63	40	5.6	7,40
RNF 60	RP 60 19 F0	60	19	M 20x40	22	13	72	20	6.2	8,70
RNF 65	RP 65 19 F0	65	19	M 20x40	22	13	72	20	6.5	9,30
RNF 70	RP 70 19 F0	70	19	M 20x40	22	13	72	20	6.8	10,00
RNF 80	RP 80 23 F0	80	23	M 20x40	22	10	73	10	4.2	11,20



# Piastre e Rulli Guida

## Ruote in nylon piano con cuscinetto e piastra

- Plain nylon wheels with bearing and plate for special guides
- Führungsrolle aus Nylon mit Lager und Montageplatte
- Roue en nylon avec roulement et plaque pour guide spécial
- Rueda nylon plana con placa y cojinete

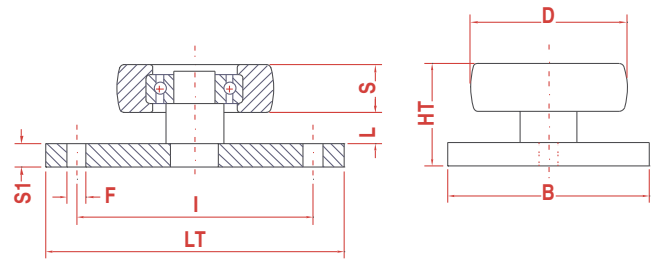

ARTICOLO - ARTICLE		D	S	BxS1	L	HT	F	I	LT				
Riferimento-Reference		∅		mm			∅	mm			N°	kg	x1
RNP 40	RP 40 15 P0	40	15	30x6	10	31	8	90	100	40	9.2	9,00	
RNP 48	RP 48 15 P0	48	15	30x6	10	31	8	90	100	30	7.2	10,50	
RNP 60	RP 60 19 P0	60	19	30x6	10	35	10	90	120	20	6.7	11,90	
RNP 65	RP 65 19 P0	65	19	30x6	10	35	10	90	120	20	6.9	12,50	
RNP 70	RP 70 19 P0	70	19	30x6	10	35	10	90	120	20	7.1	13,10	
RNP 80	RP 80 23 P0	80	23	50x8	10	41	10	100	120	10	6.6	14,60	

## Guida superiore per portoni scorrevoli grezza • zincata

- Special guide for sliding gates black or galvanised
- Schiene fuer Führungsrolle, roh oder verzinkt
- Guide supérieur pour porte coulissante - existe en noir et zingué
- Guía superior para portones correzidos non cincada y cincada

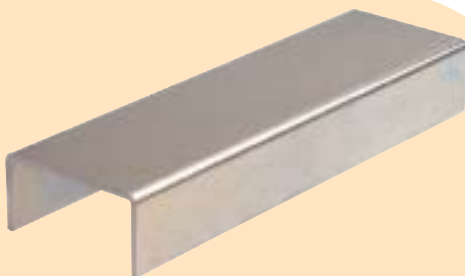
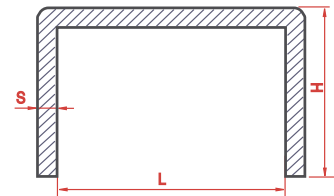

ARTICOLO - ARTICLE		L	S	H	DESCRIZIONE DESCRIPTION	FASCI - SHEAFS	kg		
Riferimento-Reference		mm						x1 ML	
58/40 G	BG 42 35 00	42	3	35	GREZZO da ML 6	ML 120	312	4,30	
58/40 Z	BZ 42 35 00	42	3	35	ZINCATO da ML 6	ML 120	312	6,40	
58/48 G	BG 50 35 00	50	3	35	GREZZO da ML 6	ML 120	340	4,70	
58/48 Z	BZ 50 35 00	50	3	35	ZINCATO da ML 6	ML 120	340	7,20	
58/60 G	BG 62 40 00	62	3	35	GREZZO da ML 6	ML 120	370	5,60	
58/60 Z	BZ 62 40 00	62	3	35	ZINCATO da ML 6	ML 120	370	8,30	
58/65 G	BG 67 40 00	67	3	40	GREZZO da ML 6	ML 120	420	5,80	
58/65 Z	BZ 67 40 00	67	3	40	ZINCATO da ML 6	ML 120	420	8,60	
58/70 G	BG 72 40 00	72	3	40	GREZZO da ML 6	ML 120	438	6,00	
58/70 Z	BZ 72 40 00	72	3	40	ZINCATO da ML 6	ML 120	438	8,90	
58/80 G	BG 82 45 00	82	3	45	GREZZO da ML 6	ML 120	480	6,60	
58/80 Z	BZ 82 45 00	82	3	45	ZINCATO da ML 6	ML 120	480	9,70	

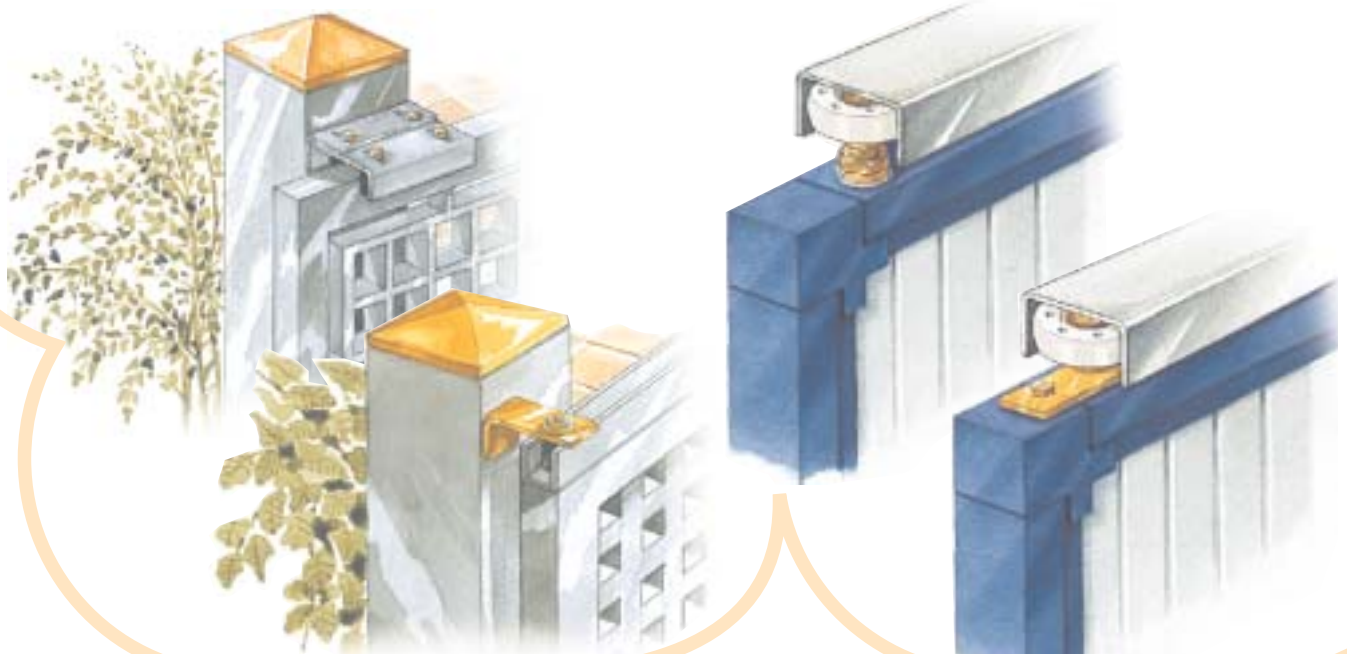

## **Cardini**

-  Hinges
-  Torbänder
-  Gonds
-  Pernios





**pag.6-18**

## **Cerniere·Catenacci**

-  Hinges - Bolts
-  Scharniere - Riegel
-  Charnières - Verrous
-  Bisagras - Cerrojos

**pag.19-29**

## **Ruote cremagliere e guide**

-  Wheels/racks/guides
-  Laufrollen/Schienen
-  Roues/Crémaillères/rails
-  Ruedas, cremalleras y guías

**pag.30-52**

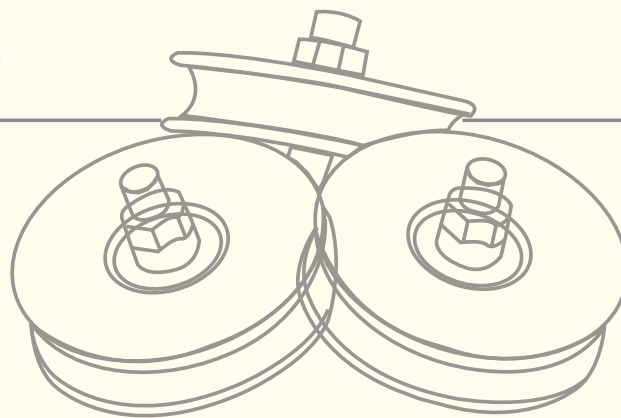





## **Piastre e rulli guida**

-  Rollers guide
-  Führungsrollen
-  Plots de guidage
-  Placas y Rodillos





**pag.53-57**

## **Accessori per portoni·Cuscinetti**

-  Accessories for sliding and folding doors and bearings
-  Zubehör fuer falt-und Schiebetore, Lagern
-  Accessoires pour portes coulissantes et accordéon
-  Accesorios para puertas correderas y plegables

**pag.58-93**

## **Carrelli autoportanti**

-  Cantilever gate carriages
-  Wagen fuer freitragende Schiebetore
-  Chariots pour portail autoportants
-  Carros para cancelas autoportantes

**pag.94-97**